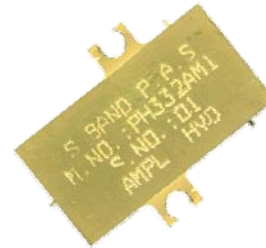
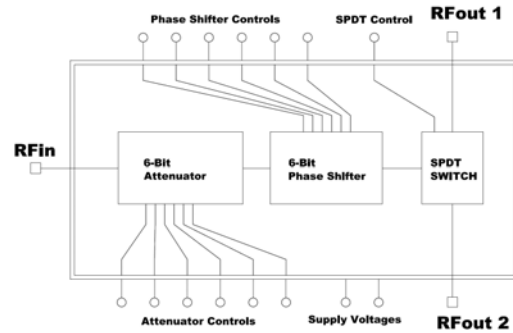

## S-band T/R Control Module

### Features

- ◆ Dual path, Transmit/Receive Operation
- ◆ 6-Bit Digital Attenuator, 6-Bit Digital Phase shifter and high Isolation SPDT Switch
- ◆ Low Insertion loss ~ 9.5dB
- ◆ Switch Isolation ~60dB
- ◆ 1.4:1 I/O VSWR
- ◆ On-chip TTL integrated control Inputs
- ◆ Hermetically sealed Module
- ◆ 50Ω Input and Output Impedance
- ◆ 0.5μm InGaAs pHEMT Technology
- ◆ High Switching Speed
- ◆ 23mm x19mm x 4.7mm compact package

**Functional Diagram**

### Typical Applications

- ◆ RADAR Systems

### Description

The AMT-PH332AM1 is a 3-port, dual path S-band transmit/receive control MMIC module. The module incorporates a 6-bit Phase Shifter, 6-Bit Attenuator and a high isolation SPDT switch. The on-chip TTL compatible drivers minimize the required inputs. The module is compact, lightweight and hermetically sealed for reliable operation. The hermetically sealed package is compatible with conventional assembly procedures. The RF ports are DC coupled and require external coupling capacitors for reliable operation. This product is fully matched to 50ohms at all the three RF ports. The constituent MMICs are fabricated using a highly reliable and high performance InGaAs 0.5μm pHEMT Technology. The MMICs are fully protected with Silicon Nitride passivation to obtain highest level of reliability.

### Absolute Maximum Ratings<sup>1</sup>

Parameter	Absolute Maximum	Units
RF input Power ( common Port)	25	dBm
RF input Power ( switch ports)	25	dBm
Positive supply Voltage	+7	V
Negative supply voltage	-7	V
Control voltage	+6	V
Storage Temperature	-55 to +120	°C

1. Operation beyond these limits may cause permanent damage to the component

**Electrical Specifications @  $T_A = 25^\circ\text{C}$  ,  $Z_o = 50 \Omega$** 

Parameter	Typical	Units
Bandwidth	3.1-3.5	GHz
<b>Attenuation Range(6 bits,64 states)</b>	0 to 31.5	dB
0.5dB Bit, Relative gain, LSB	-0.5	dB
1dB Bit, Relative gain	-1.0	dB
2dB Bit, Relative gain	-2.0	dB
4dBBit, Relative gain	-4.0	dB
8dBBit, Relative gain	-8.0	dB
16dBBit, Relative gain, MSB	-16.0	dB
<b>Phase Shifter Range(6 bits, 64 states)</b>	0 to 360	Deg.
5.625 <sup>0</sup> Bit Relative Phase, LSB	-5.625	Deg.
11.25 <sup>0</sup> Bit Relative Phase	-11.25	Deg.
22.5 <sup>0</sup> Bit Relative Phase	-22.5	Deg.
45 <sup>0</sup> Bit Relative Phase	-45	Deg.
90 <sup>0</sup> Bit Relative Phase	-90	Deg.
180 <sup>0</sup> Bit Relative Phase, MSB	-180	Deg.
<b>SPDT Switch</b>		
On-State Relative gain	-1.0	dB
Off-State Relative gain	-60	dB
Isolation	55	dB
<b>Cascaded Performance</b>		
Insertion Loss	9.5	dB
Phase shift	0 to 360	Deg.
Input VSWR	1.2:1	-
Output VSWR	1.4:1	-
Attenuator Amplitude error with phase shifter in reference state	±0.2	dB
Attenuator Phase Variation with phase shifter in reference state	3.0	Deg.
Phase shifter Amplitude error @ Minimum Attenuation state	±0.5	dB
Phase shifter peak phase error @ Minimum Attenuation state	-2.5,+4.5	Deg.
RMS Attenuation error	< 0.1	dB
RMS Phase error	< 2.25	Deg.
Control Voltage	TTL Compatible	-
DC supply voltages	+5,-5	V

## Test fixture data

$T_A = 25^\circ C$ ,  $Z_o = 50 \Omega$

### Insertion Loss

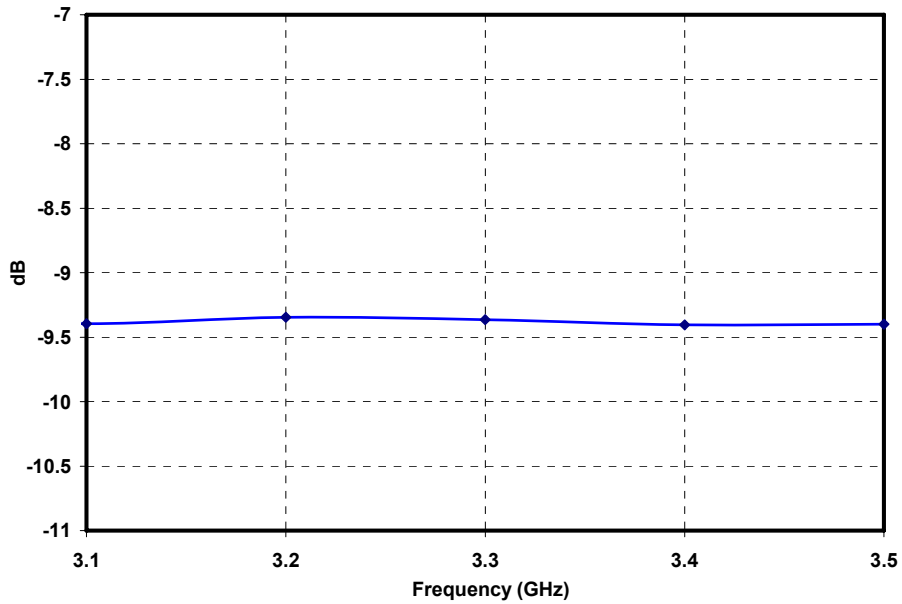

### Return Loss - Common Port

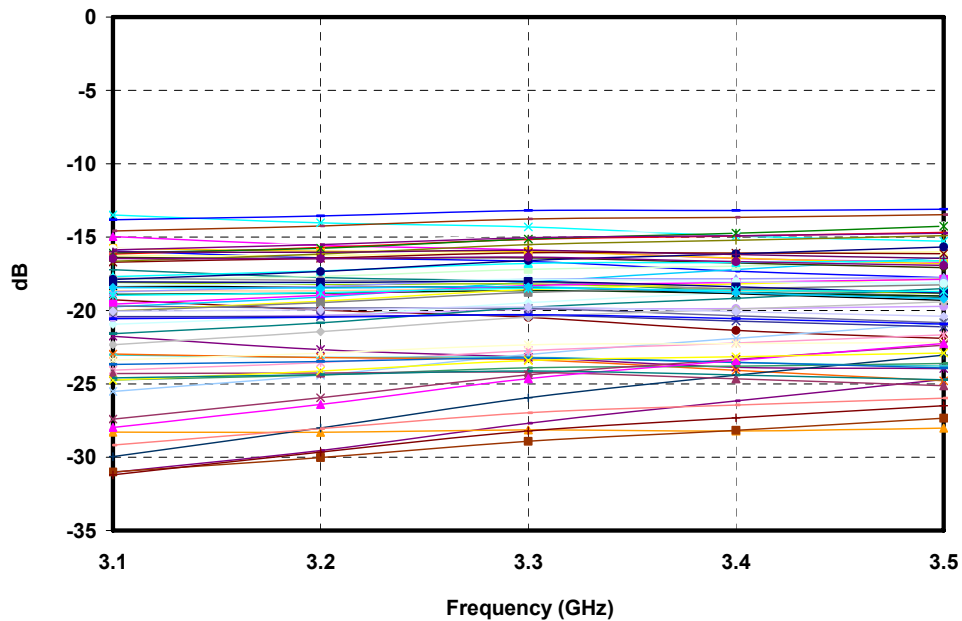

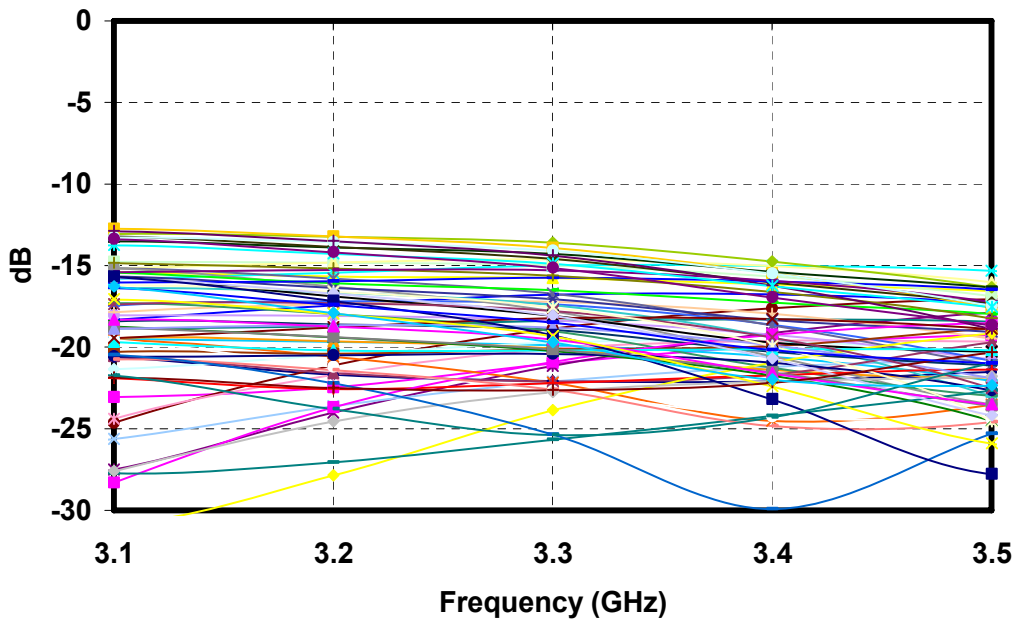
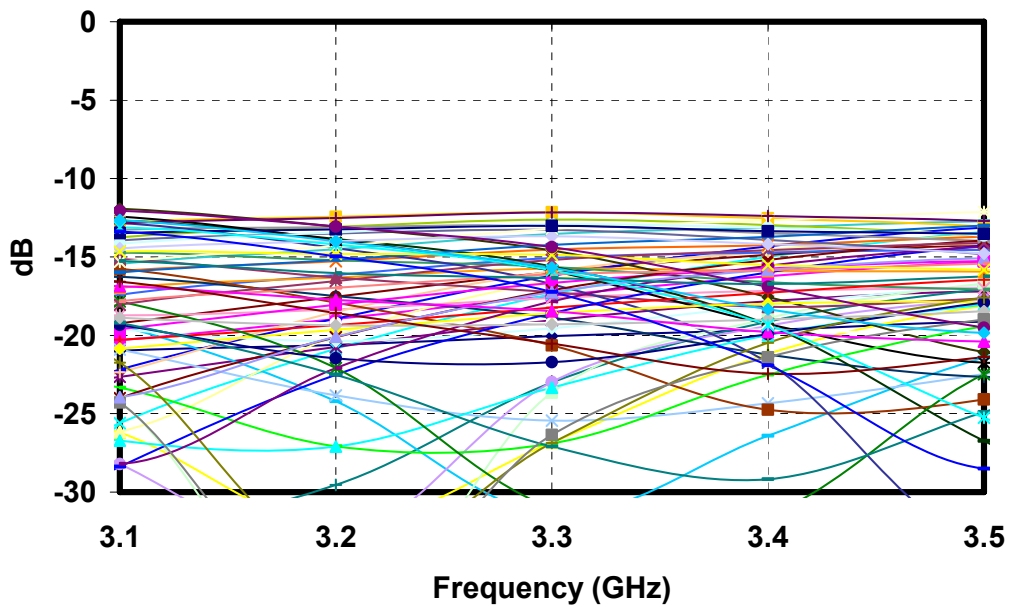
**Test fixture data** $T_A = 25^\circ\text{C}$ ,  $Z_o = 50\ \Omega$ **Return Loss - Switch Port 1****Return loss - Switch Port 2**

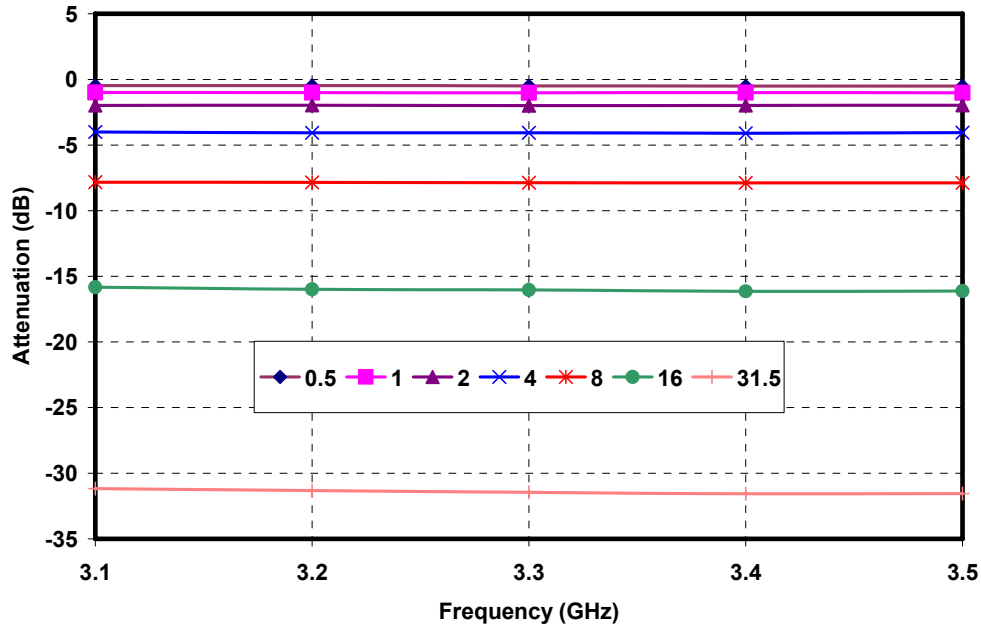
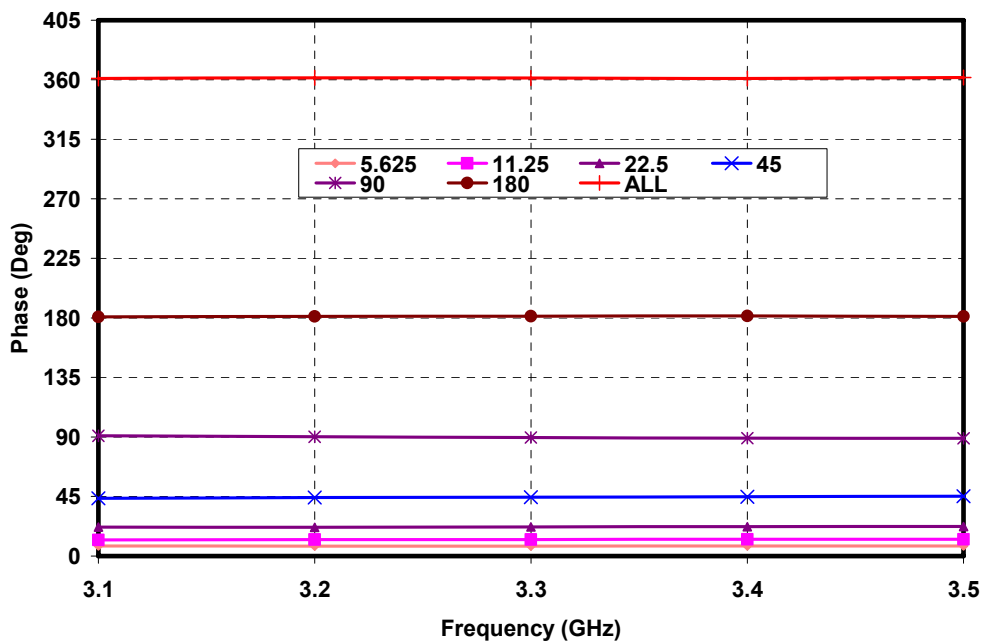
**Test fixture data**
 $T_A = 25^\circ C, Z_o = 50 \Omega$ 
**Relative Gain of Major Attenuation States**

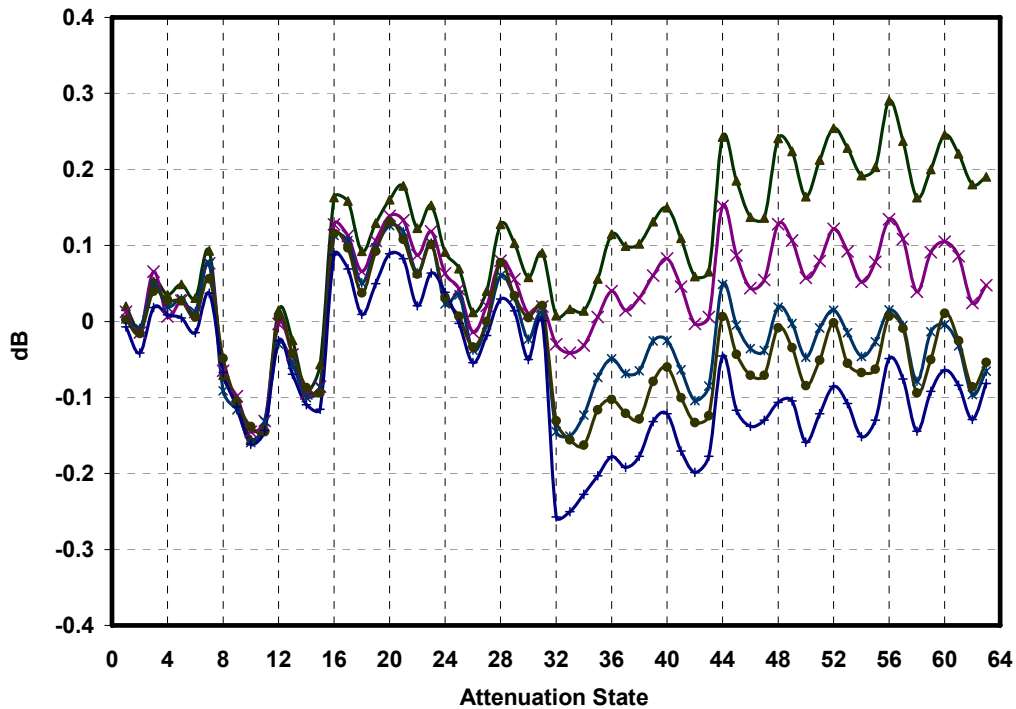
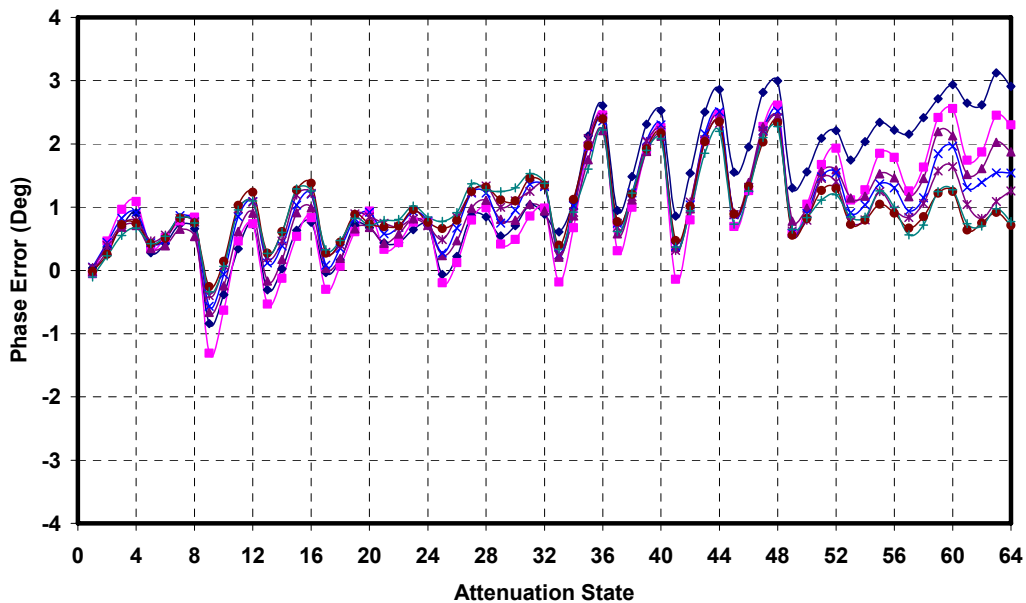
**Relative Phase of Major Phase States**

**Test fixture data**
 $T_A = 25^\circ\text{C}, Z_o = 50\ \Omega$ 
**Attenuator Amplitude Error with Phase Shifter in Reference**

**Attenuator Phase Error with Phase Shifter in Reference State**

**Test fixture data**

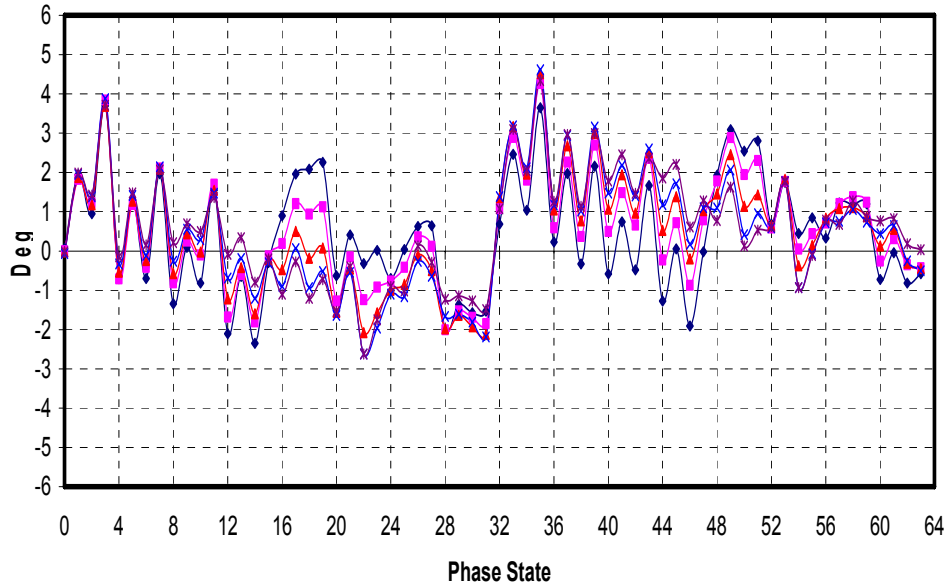
$T_A = 25^\circ C, Z_o = 50 \Omega$

**Phase Error of Phase Shifter at Minimum Attenuation State**



**Amplitude Error of Phase Shifter at Minimum Attenuator State**

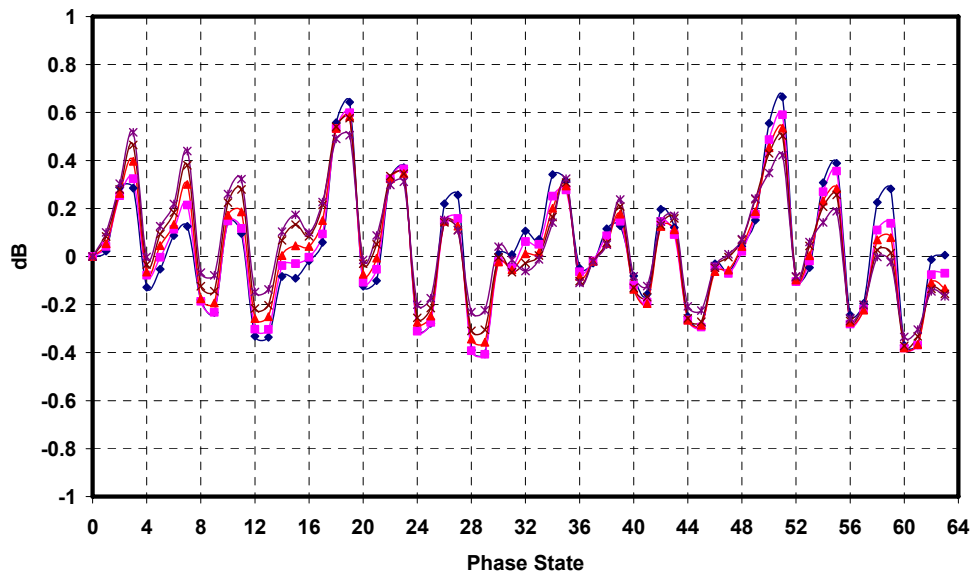

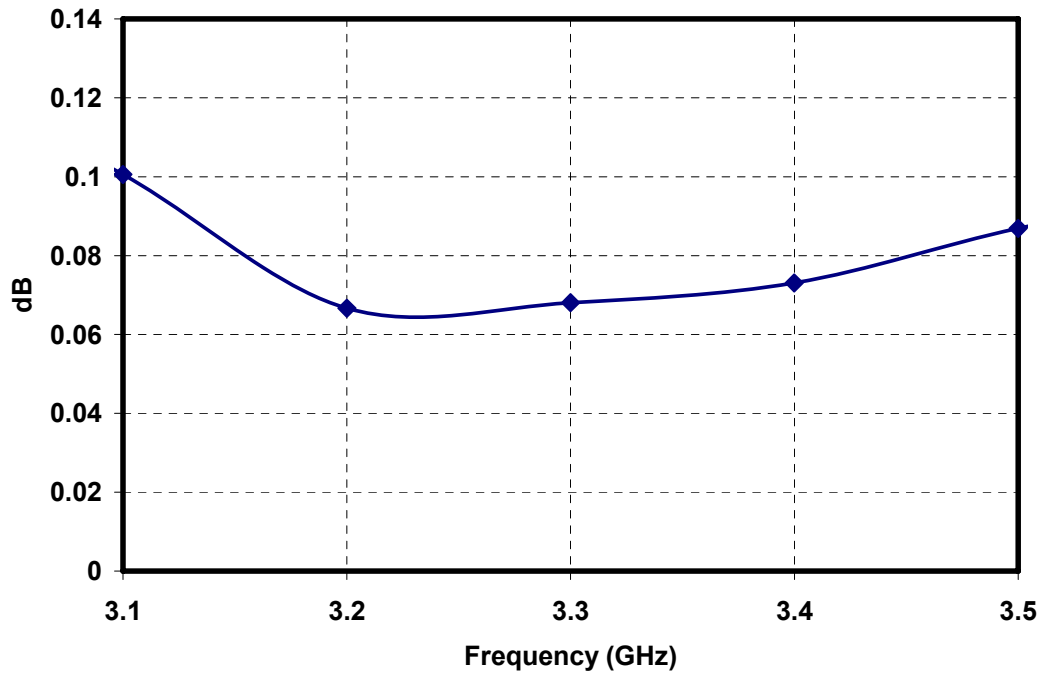
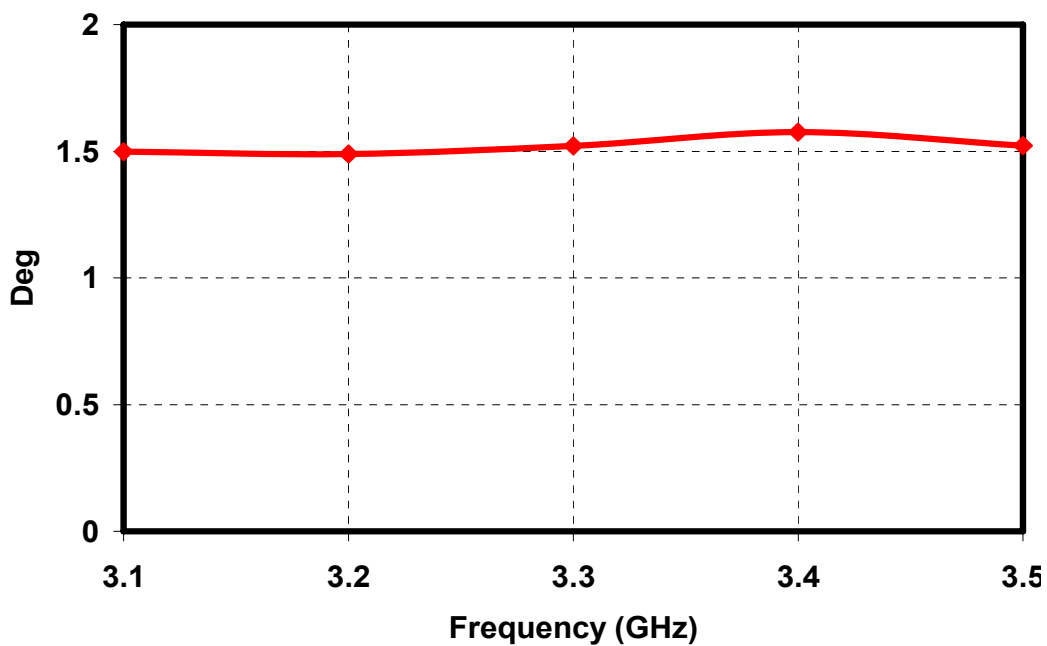
**Test fixture data** $T_A = 25^\circ\text{C}$ ,  $Z_o = 50\ \Omega$ **RMS Attenuation Error****RMS Phase Error**



**Test fixture data**

$T_A = 25^\circ C, Z_o = 50 \Omega$

**Attenuation Linearity**

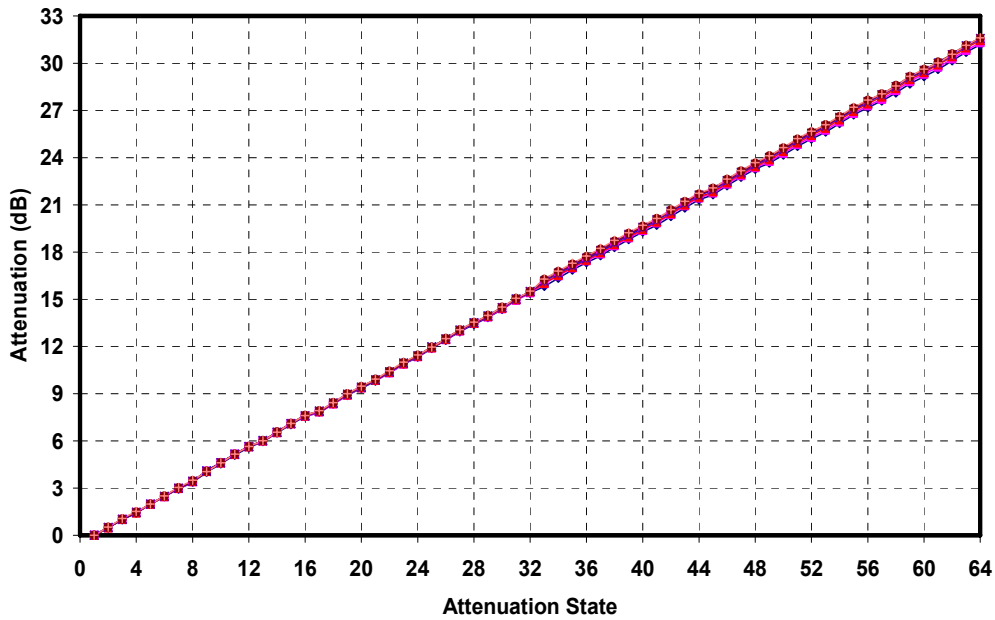

**Phase Linearity**

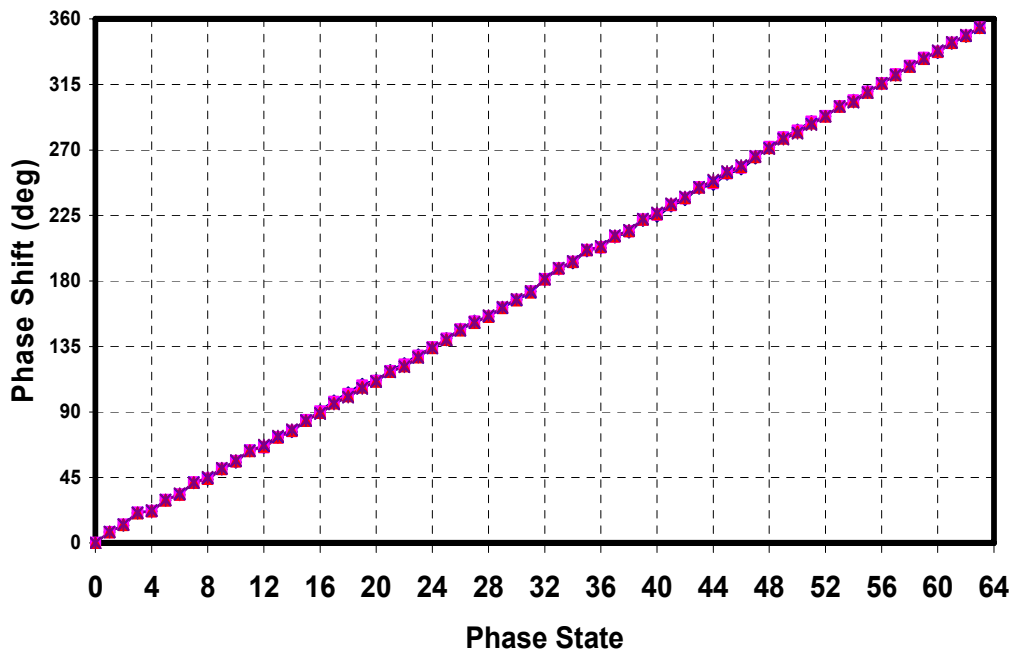

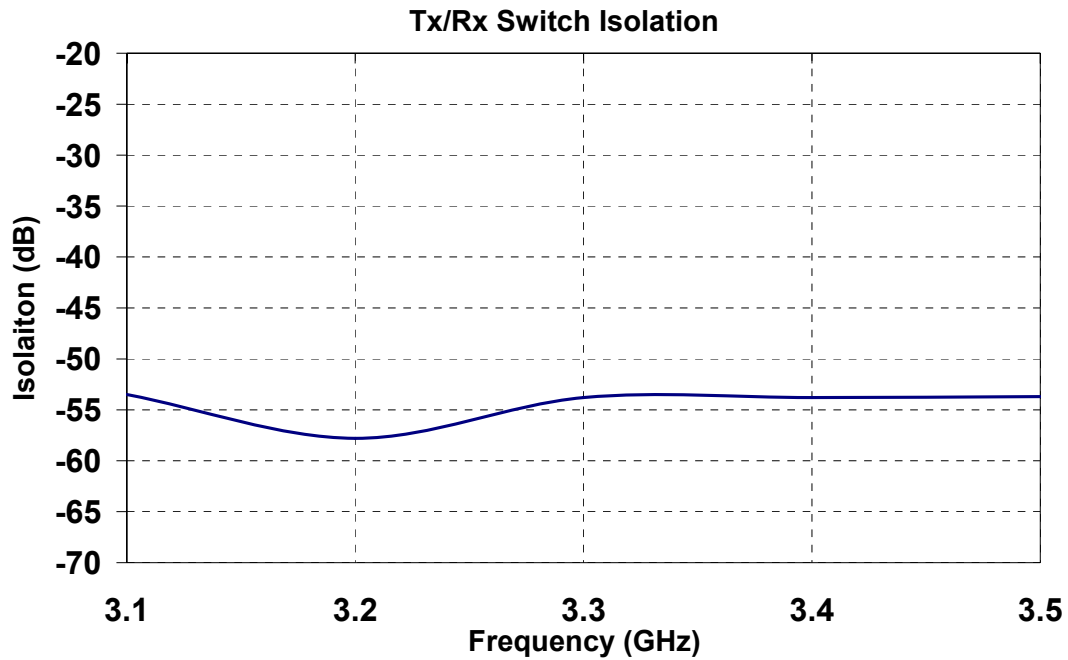
**Test fixture data** $T_A = 25^\circ\text{C}$ ,  $Z_o = 50\ \Omega$ 

## Mechanical Characteristics

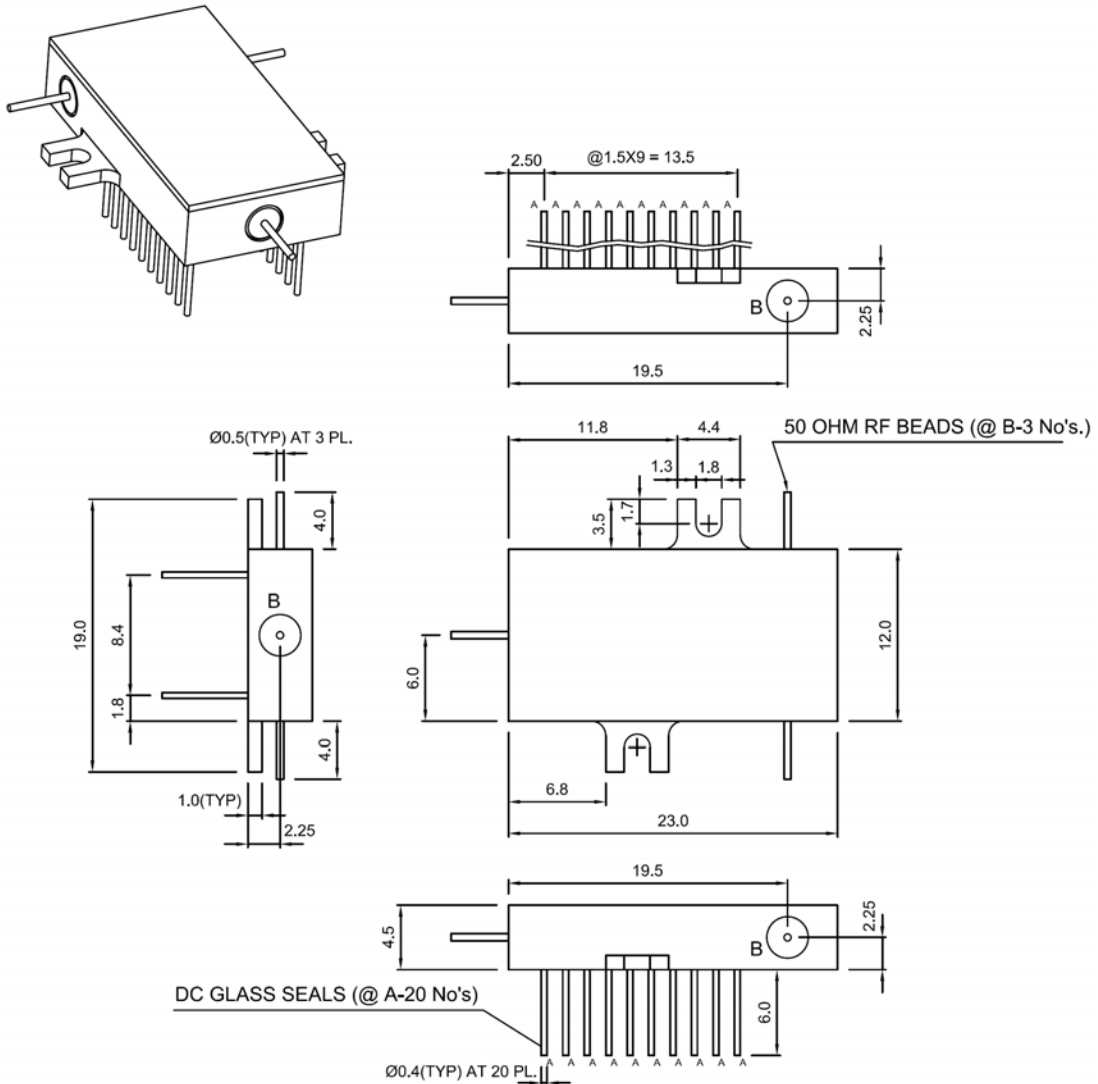

ALL DIMENSIONS ARE IN mm					
TOLERANCE ON HOLE CENTERS ±0.1. UNSPECIFIED					
RANGE	0 TO 6	>6 TO 30	>30 TO 120	>120 TO 400	>400 TO 1000
TOL.	±0.05	±0.1	±0.15	±0.2	±0.3

## Pin Number Designation

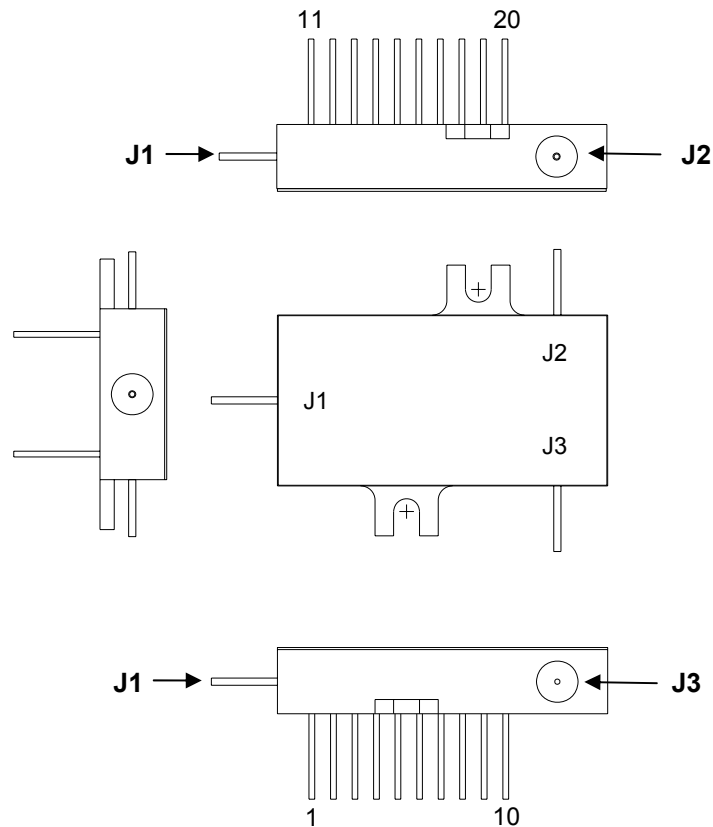

PIN CONFIGURATION			
J1	: RF IN	J2	: O/P-1
PIN 1	: +5V (ATTN.)	PIN 11	: +5V (P.S)
PIN 2	: -5V (ATTN.)	PIN 12	: -5V (P.S)
PIN 3	: A1 (ATTN.)	PIN 13	: A1 (P.S)
PIN 4	: A2 (ATTN.)	PIN 14	: A2 (P.S)
PIN 5	: A3 (ATTN.)	PIN 15	: A3 (P.S)
PIN 6	: A4 (ATTN.)	PIN 16	: A4 (P.S)
PIN 7	: A5 (ATTN.)	PIN 17	: A5 (P.S)
PIN 8	: A6 (ATTN.)	PIN 18	: A6 (P.S)
PIN 9	: GND	PIN 19	: +5V (SW)
PIN 10	: -5V (SW)	PIN 20	: V_CTRL (SW)
J3	: O/P-2		

**Note:**

1. **ATTN.** are the Attenuator controls ; **P.S.** are the Phase Shifter controls; **SW** are Switch Controls.
2. RF ports J1, J2, & J3 are DC coupled and require external capacitors ( ~ 50-100pF) for reliable operation

## Truth Table

### SPDT Switch

S. No.	Switch Control	Active RF Path
1	0	J1 – J3
2	1	J1 – J2

### Phase Shifter

S.No.	Phase Shift	180Deg	90Deg	45Deg	25Deg	11.25Deg	5.625Deg
		A6	A5	A4	A3	A2	A1
1	0	0	0	0	0	0	0
2	5.625	0	0	0	0	0	1
3	11.25	0	0	0	0	1	0
4	16.875	0	0	0	0	1	1
5	22.5	0	0	0	1	0	0
6	28.125	0	0	0	1	0	1
7	33.75	0	0	0	1	1	0
8	39.375	0	0	0	1	1	1
9	45	0	0	1	0	0	0
10	50.625	0	0	1	0	0	1
11	56.25	0	0	1	0	1	0
12	61.875	0	0	1	0	1	1
13	67.5	0	0	1	1	0	0
14	73.125	0	0	1	1	0	1
15	78.75	0	0	1	1	1	0
16	84.375	0	0	1	1	1	1
17	90	0	1	0	0	0	0
18	95.625	0	1	0	0	0	1
19	101.25	0	1	0	0	1	0
20	106.875	0	1	0	0	1	1
21	112.5	0	1	0	1	0	0
22	118.125	0	1	0	1	0	1
23	123.75	0	1	0	1	1	0
24	129.375	0	1	0	1	1	1
25	135	0	1	1	0	0	0
26	140.625	0	1	1	0	0	1

S.No.	Phase Shift	180Deg	90Deg	45Deg	25Deg	11.25Deg	5.625Deg
		A6	A5	A4	A3	A2	A1
27	146.25	0	1	1	0	1	0
28	151.875	0	1	1	0	1	1
29	157.5	0	1	1	1	0	0
30	163.125	0	1	1	1	0	1
31	168.75	0	1	1	1	1	0
32	174.375	0	1	1	1	1	1
33	180	1	0	0	0	0	0
34	185.625	1	0	0	0	0	1
35	191.25	1	0	0	0	1	0
36	196.875	1	0	0	0	1	1
37	202.5	1	0	0	1	0	0
38	208.125	1	0	0	1	0	1
39	213.75	1	0	0	1	1	0
40	219.375	1	0	0	1	1	1
41	225	1	0	1	0	0	0
42	230.625	1	0	1	0	0	1
43	236.25	1	0	1	0	1	0
44	241.875	1	0	1	0	1	1
45	247.5	1	0	1	1	0	0
46	253.125	1	0	1	1	0	1
47	258.75	1	0	1	1	1	0
48	264.375	1	0	1	1	1	1
49	270	1	1	0	0	0	0
50	275.625	1	1	0	0	0	1
51	281.25	1	1	0	0	1	0
52	286.875	1	1	0	0	1	1
53	292.5	1	1	0	1	0	0
54	298.125	1	1	0	1	0	1
55	303.75	1	1	0	1	1	0
56	309.375	1	1	0	1	1	1
57	315	1	1	1	0	0	0
58	320.625	1	1	1	0	0	1
59	326.25	1	1	1	0	1	0
60	331.875	1	1	1	0	1	1
61	337.5	1	1	1	1	0	0
62	343.125	1	1	1	1	0	1
63	348.75	1	1	1	1	1	0
64	354.375	1	1	1	1	1	1

**Attenuator**

S.No.	Attenuation State	16 dB A6	8 dB A5	4 dB A4	2 dB A3	1 dB A2	0.5 dB A1
1	0	0	0	0	0	0	0
2	0.5	0	0	0	0	0	1
3	1	0	0	0	0	1	0
4	1.5	0	0	0	0	1	1
5	2	0	0	0	1	0	0
6	2.5	0	0	0	1	0	1
7	3	0	0	0	1	1	0
8	3.5	0	0	0	1	1	1
9	4	0	0	1	0	0	0
10	4.5	0	0	1	0	0	1
11	5	0	0	1	0	1	0
12	5.5	0	0	1	0	1	1
13	6	0	0	1	1	0	0
14	6.5	0	0	1	1	0	1
15	7	0	0	1	1	1	0
16	7.5	0	0	1	1	1	1
17	8	0	1	0	0	0	0
18	8.5	0	1	0	0	0	1
19	9	0	1	0	0	1	0
20	9.5	0	1	0	0	1	1
21	10	0	1	0	1	0	0
22	10.5	0	1	0	1	0	1
23	11	0	1	0	1	1	0
24	11.5	0	1	0	1	1	1
25	12	0	1	1	0	0	0
26	12.5	0	1	1	0	0	1
27	13	0	1	1	0	1	0
28	13.5	0	1	1	0	1	1
29	14	0	1	1	1	0	0
30	14.5	0	1	1	1	0	1
31	15	0	1	1	1	1	0
32	15.5	0	1	1	1	1	1
33	16	1	0	0	0	0	0

S.No.	Attenuation State	16 dB A6	8 dB A5	4 dB A4	2 dB A3	1 dB A2	0.5 dB A1
34	16.5	1	0	0	0	0	1
35	17	1	0	0	0	1	0
36	17.5	1	0	0	0	1	1
37	18	1	0	0	1	0	0
38	18.5	1	0	0	1	0	1
39	19	1	0	0	1	1	0
40	19.5	1	0	0	1	1	1
41	20	1	0	1	0	0	0
42	20.5	1	0	1	0	0	1
43	21	1	0	1	0	1	0
44	21.5	1	0	1	0	1	1
45	22	1	0	1	1	0	0
46	22.5	1	0	1	1	0	1
47	23	1	0	1	1	1	0
48	23.5	1	0	1	1	1	1
49	24	1	1	0	0	0	0
50	24.5	1	1	0	0	0	1
51	25	1	1	0	0	1	0
52	25.5	1	1	0	0	1	1
53	26	1	1	0	1	0	0
54	26.5	1	1	0	1	0	1
55	27	1	1	0	1	1	0
56	27.5	1	1	0	1	1	1
57	28	1	1	1	0	0	0
58	28.5	1	1	1	0	0	1
59	29	1	1	1	0	1	0
60	29.5	1	1	1	0	1	1
61	30	1	1	1	1	0	0
62	30.5	1	1	1	1	0	1
63	31	1	1	1	1	1	0
64	31.5	1	1	1	1	1	1



***GaAs MMIC devices are susceptible to Electrostatic discharge. Proper precautions should be observed during handling, assembly & testing***

All information and Specifications are subject to change without prior notice